

**Installationsvejledning**  
**Montageanweisung**  
**Installation instruction**  
**Instructions d'installation**  
**Istruzioni di installazione**  
**Installatie- -instructies**  
**Instrucciones de instalación**

# damixa

Østbirkvej 2, 5240 Odense NØ, Denmark  
 Tel. +88 330 034  
 E-mail: damixa@fmm-mora.com  
 Homepage: www.damixa.com

03.20

12150.00

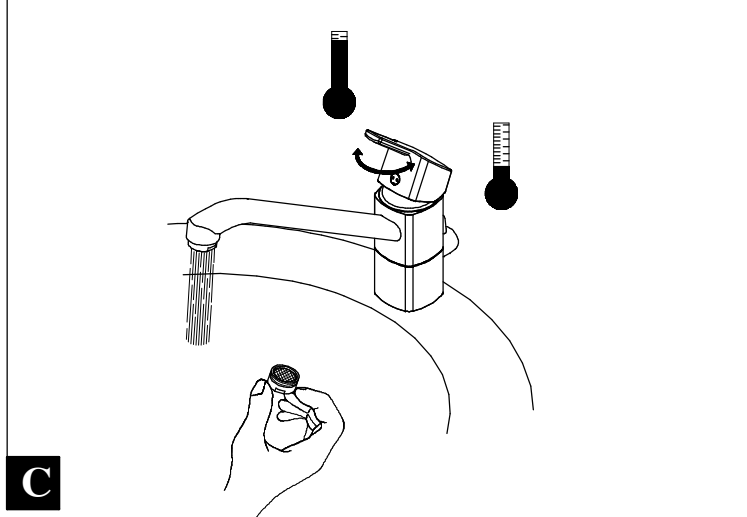
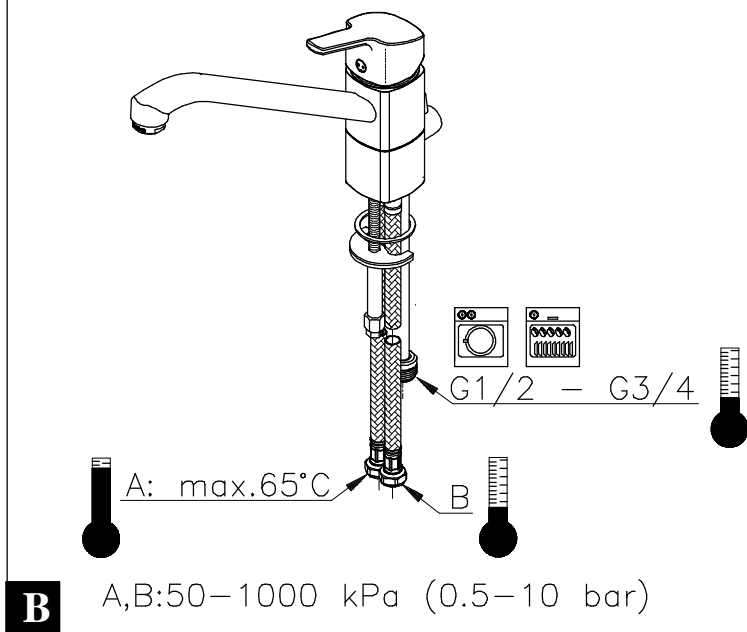
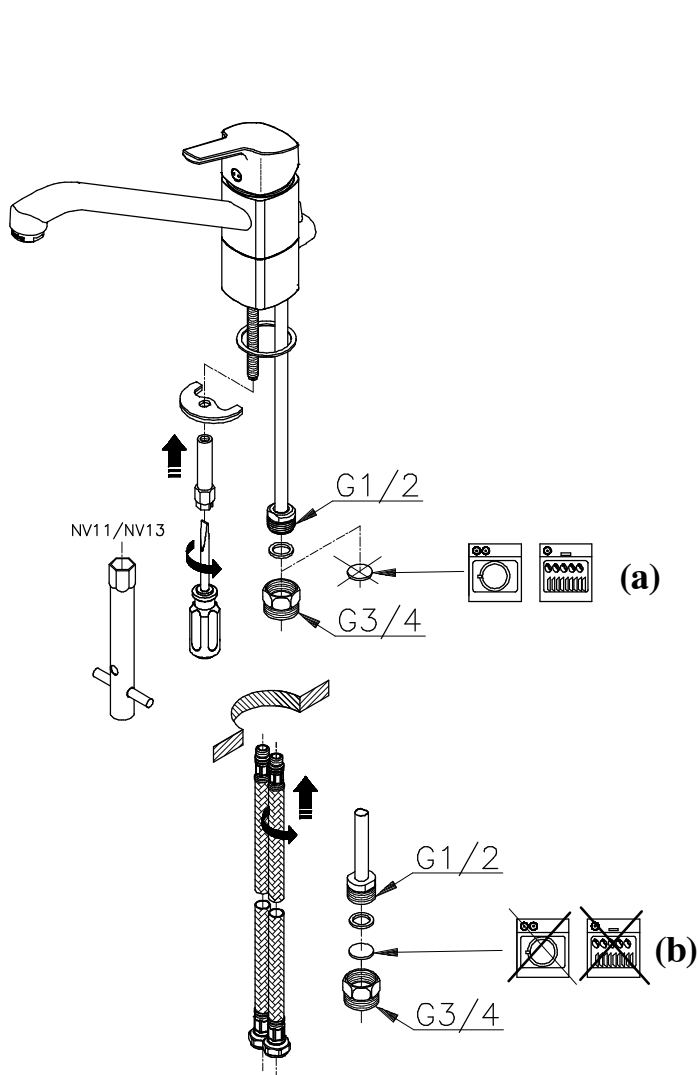
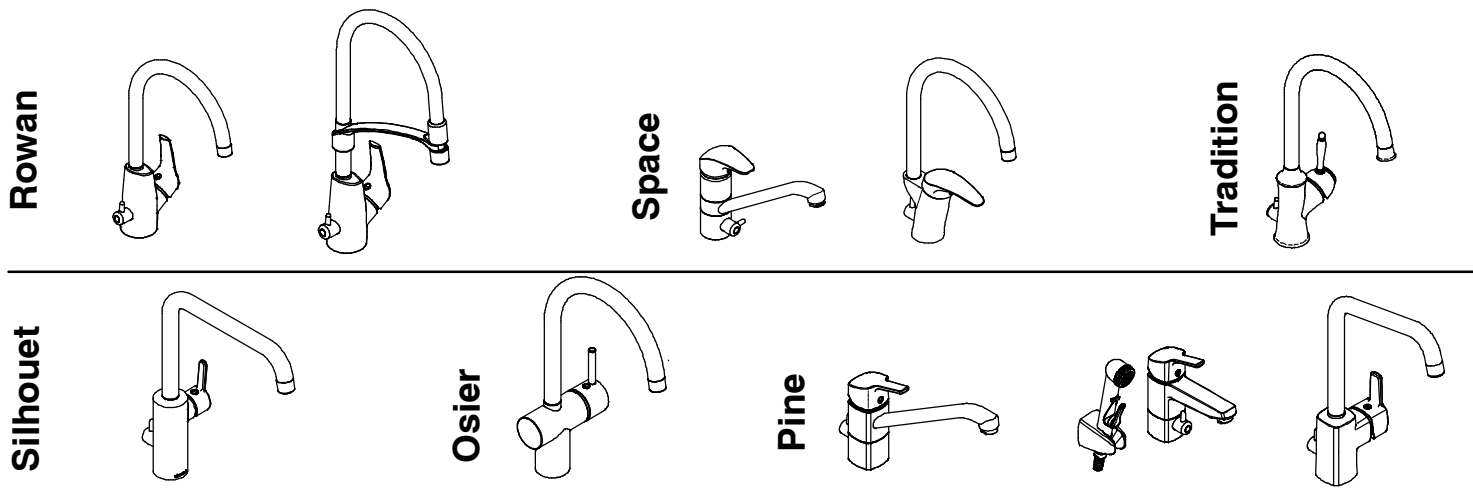

**A**

**C**

17039

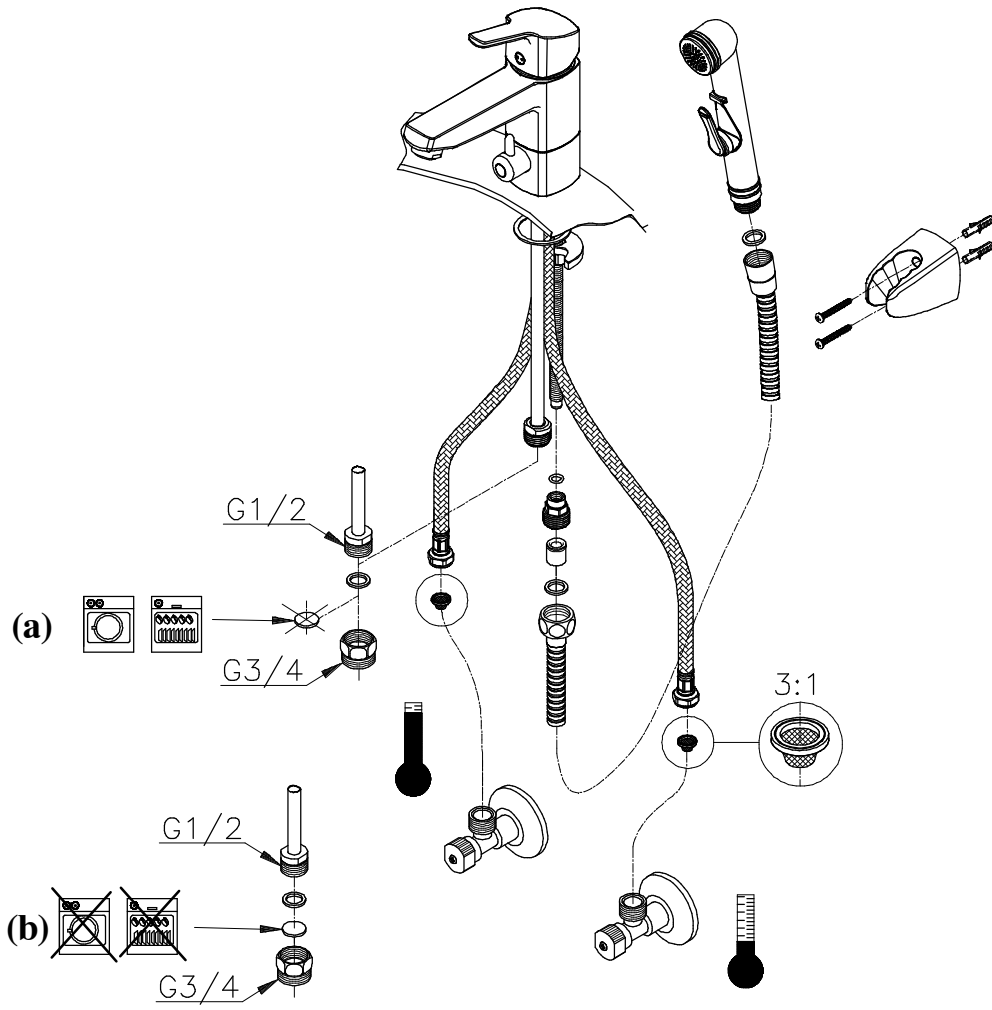

17039

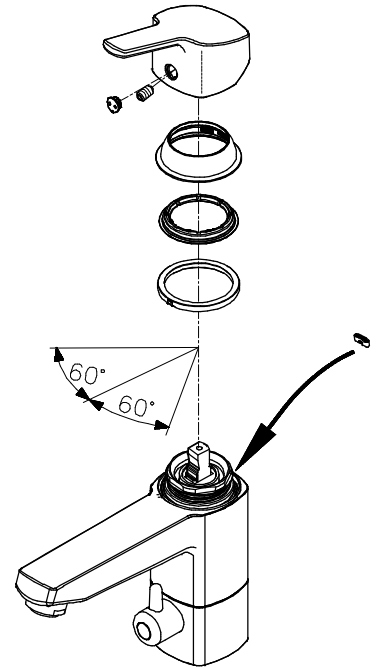

**D**

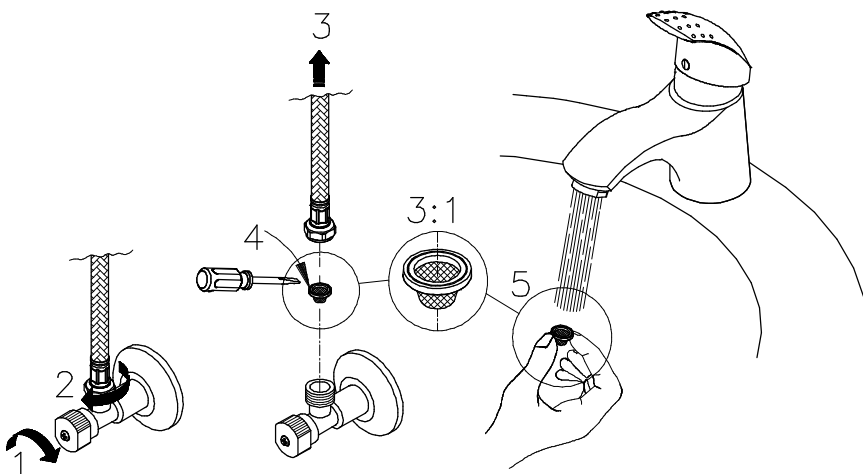

**E**

